

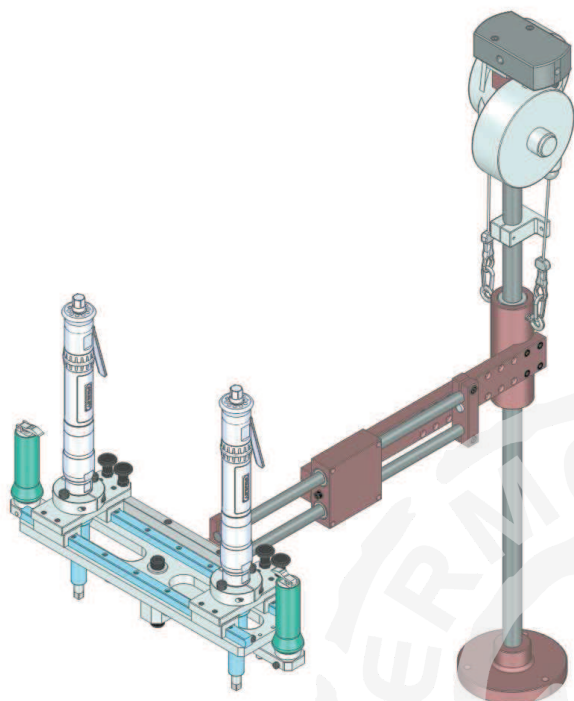

Special arms

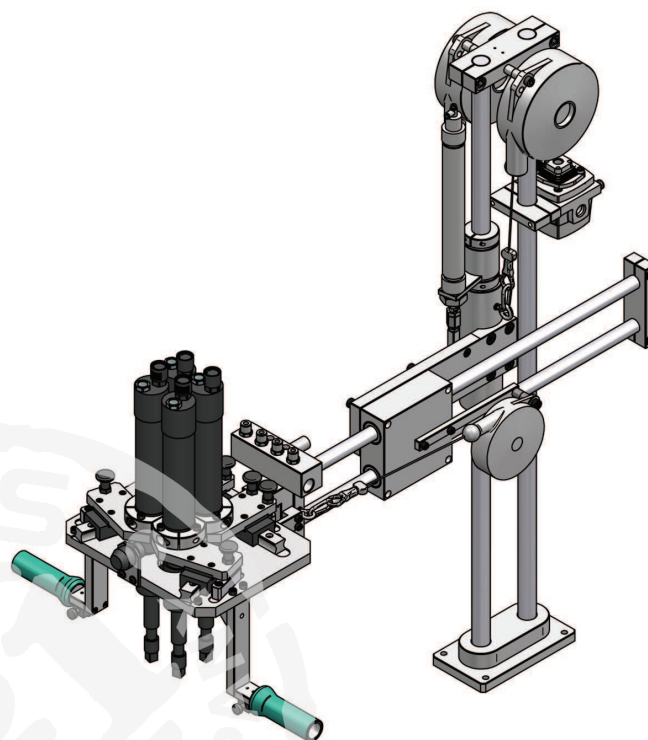

BA for double spindle with variable pitch



BA 200 with 4 spindles + easy push kit



SLIDER 50 COMPACT :

- With rail
- With air locker
- With rotative clamp

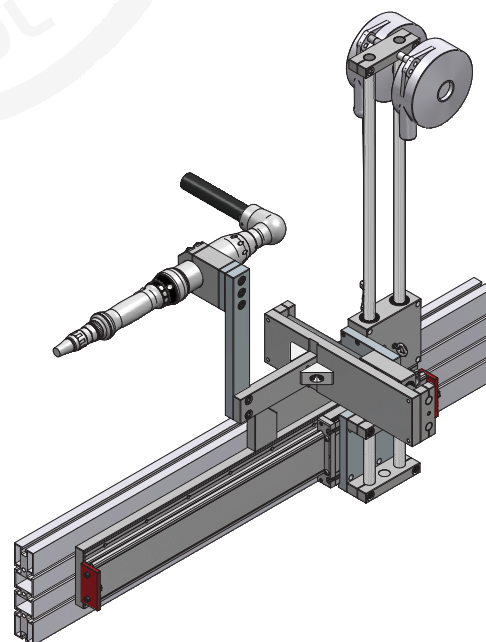

Cartesian arm, 3 axes

Special arms

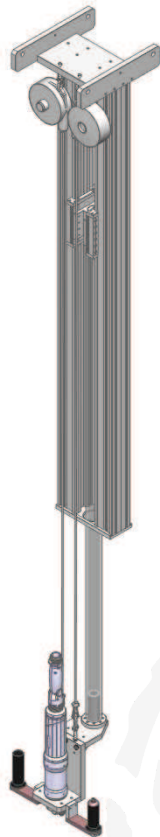

SLIDER 300 COMPACT for straight nutrunner

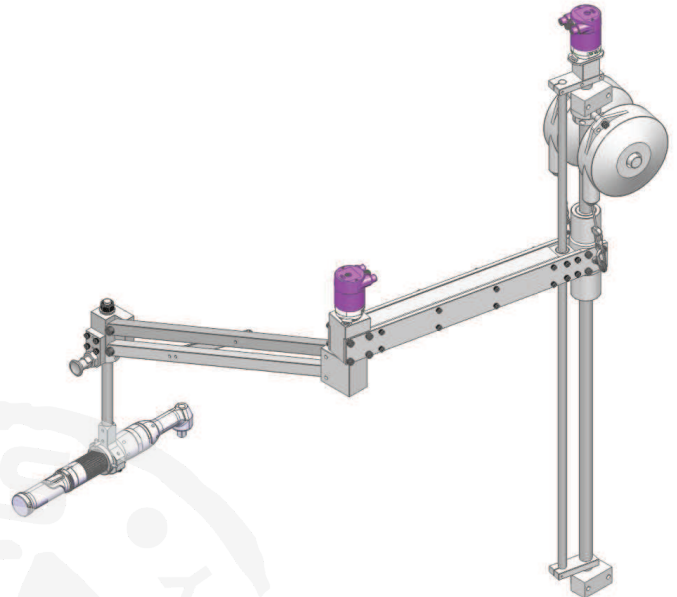

BA 130 R with :
- Profinet coders
- Rotative and swivelling clamp

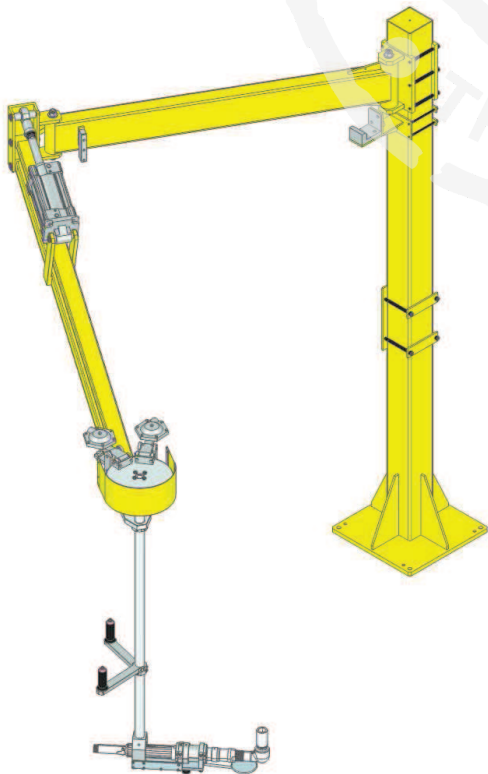

BA 500R/3000 with :
- Disk break
- Rotative clamp

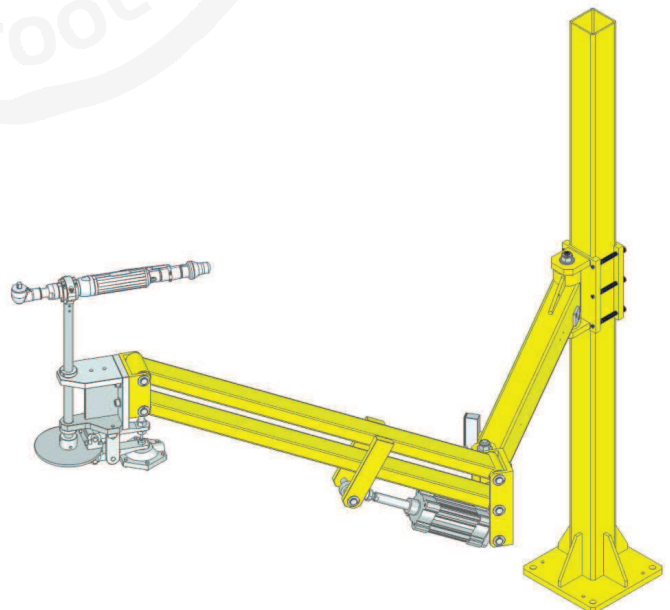

BA 200 R for under body tightening :
- With disk break
- Rotative clamp